

EXAMINED BY :	<p style="text-align: center;"><b>EMERGING DISPLAY</b></p> <p style="text-align: center;">TECHNOLOGIES CORPORATION</p>	FILE NO . CAS-
APPROVED BY:		ISSUE : JAN.10, 2018
		TOTAL PAGE : 21
		VERSION : 1

CUSTOMER                      ACCEPTANCE                      SPECIFICATIONS

MODEL NO. :

ETEM043005XDH6

(RoHS)

FOR MESSRS :

\_\_\_\_\_

CUSTOMER'S APPROVAL

DATE :

\_\_\_\_\_

BY :

\_\_\_\_\_

EMERGING DISPLAY  
TECHNOLOGIES CORPORATION

MODEL NO.	VERSION	PAGE
E TEM043005XDH6	1	0-1

RECORDS OF REVISION	DOC . FIRST ISSUE	JAN.10, 2018
---------------------	-------------------	--------------

DATE	REVISED PAGE NO.	SUMMARY

TABLE OF CONTENTS

NO.	ITEM	PAGE
1.	GENERAL SPECIFICATIONS -----	1
2.	MECHANICAL SPECIFICATIONS -----	1
3.	ABSOLUTE MAXIMUM RATINGS -----	2
4.	ELECTRICAL CHARACTERISTICS -----	3
5.	TIMING CHARACTERISTICS -----	3
6.	MCU CHARACTERISTICS -----	3
7.	OPTICAL CHARACTERISTICS -----	4, 5
8.	OUTLINE DIMENSIONS -----	6
9.	DETAIL DRAWING OF DOT MATRIX -----	7
10.	BLOCK DIAGRAM -----	8, 9
11.	INTERFACE SIGNALS -----	10, 11
12.	POWER SUPPLY -----	12
13.	CAPACITIVE TOUCH PANEL SPECIFICATION -----	12
14.	INSPECTION CRITERION -----	13 ~ 18
15.	RELIABILITY TEST -----	19
16.	PRECAUTION -----	20, 21



## 1. GENERAL SPECIFICATIONS

### 1.1 DATA SHEETS FOR EMBEDDED SYSTEM MCU DRIVER

PLEASE REFER TO :

STM32F746

### 1.2 MATERIAL SAFETY DESCRIPTION

ASSEMBLIES COMPLY WITH EUROPEAN ROHS REQUIREMENTS, INCLUDING PROHIBITED MATERIALS/COMPONENTS CONTAINING LEAD, MERCURY, CADMIUM, HEXAVALENT CHROMIUM, POLYBROMINATED BIPHENYLS (PBB) AND POLYBROMINATED DIPHENYL ETHERS (PBDE)

## 2. MECHANICAL SPECIFICATIONS

### 2.1 EMBEDDED SYSTEM MECHANICAL SPECIFICATIONS

( 1 ) DIAGONALS	-----	4.3 inch
( 2 ) NUMBER OF DOTS	-----	480W * (RGB) * 272H DOTS
( 3 ) MODULE SIZE	-----	105.5W * 67.2H * 10.35D (MAX.) mm
( 4 ) ACTIVE AREA	-----	95.04W * 53.856H mm
( 5 ) VIEWING AREA	-----	97W * 55.65H mm
( 6 ) DOT SIZE	-----	0.066W * 0.198H mm
( 7 ) PIXEL PITCH	-----	0.198W * 0.198H mm
( 8 ) LCD TYPE	-----	TFT , TRANSMISSIVE
( 9 ) COLOR	-----	16.7M
( 10 ) VIEWING DIRECTION	-----	6 O'CLOCK (GRAY LEVEL INVERSION)
( 11 ) BACK LIGHT	-----	LED , COLOR : WHITE
( 12 ) INTERFACE MODE	-----	SPI , I2C , RS232 , RS485 , CAN BUS , GPIO

### 2.2 CAPACITIVE TOUCH PANEL MECHANICAL SPECIFICATIONS

( 1 ) TOUCH PANEL SIZE	-----	4.3 inch
( 2 ) OUTER DIMENSION	-----	103.1W * 65.4H mm
( 3 ) EFFECTIVE AREA	-----	97W * 55.65H mm
( 4 ) ACTIVE AREA	-----	96W * 55H mm
( 5 ) INPUT TYPE	-----	MULTI TOUCH *
( 6 ) NUMBER OF TOUCH SENSOR	-----	20*12 SENSORS

\*NOTE: ACCORDING TO IMPLEMENTATION DESIGN

3. ABSOLUTE MAXIMUM RATINGS

3.1 EMBEDDED SYSTEM ELECTRICAL ABSOLUTE MAXIMUM RATINGS

PARAMETER	SYMBOL	MIN.	MAX.	UNIT	REMARK
POWER VOLTAGE	VP_IN	-0.3	+40	V	VSS=0
INPUT VOLTAGE	VIN	-0.3	4.0	V	

3.2 ENVIRONMENTAL ABSOLUTE MAXIMUM RATINGS

ITEM	OPERATING		STORAGE		REMARK
	MIN.	MAX.	MIN.	MAX.	
AMBIENT TEMPERATURE	-20°C	70°C	-30°C	80°C	NOTE ( 1 ) , ( 2 )
HUMIDITY	NOTE ( 3 )		NOTE ( 3 )		WITHOUT CONDENSATION
VIBRATION	—	2.45 m/s <sup>2</sup> ( 0.25 G )	—	11.76 m/s <sup>2</sup> ( 1.2 G )	10~100Hz XYZ DIRECTIONS 1Hr. EACH
SHOCK	—	29.4 m/s <sup>2</sup> ( 3 G )	—	490 m/s <sup>2</sup> ( 50 G )	10ms XYZ DIRECTIONS 1 TIME EACH
CORROSIVE GAS	NOT ACCEPTABLE		NOT ACCEPTABLE		

NOTE ( 1 ) : Ta AT -30°C : 48HRS MAX.  
80°C : 168HRS MAX.

NOTE ( 2 ) : BACKGROUND COLOR CHANGES SLIGHTLY DEPENDING ON AMBIENT TEMPERATURE  
THIS PHENOMENON IS REVERSIBLE.

NOTE ( 3 ) : Ta ≤ 60°C : 90%RH MAX (96HRS MAX).

Ta > 60°C : ABSOLUTE HUMIDITY MUST BE LOWER THAN THE HUMIDITY  
OF 90%RH AT 60°C(96HRS MAX).

4. ELECTRICAL CHARACTERISTICS

4.1 EMBEDDED SYSTEM ELECTRICAL CHARACTERISTICS

Ta = 25 °C

PARAMETER	SYMBOL	CONDITION	MIN.	TYP.	MAX.	UNIT	REMARK
POWER SUPPLY VOLTAGE	VP_IN	—	7	12	36	V	VSS=0
POWER SUPPLY CURRENT	I <sub>VP_IN</sub>	VP_IN=7V	—	270	330	mA	—
	I <sub>VP_IN</sub>	VP_IN=12V	—	170	210	mA	—
	I <sub>VP_IN</sub>	VP_IN=36V	—	62	75	mA	—
LED LIFE TIME	—	—	30K	—	—	hrs	NOTE ( 4 ) NOTE ( 5 )

NOTE ( 1 ) : V<sub>IL</sub>/V<sub>IH</sub>/V<sub>OL</sub>/V<sub>OH</sub> REFER TO STM32F746 DATA SHEET

NOTE ( 2 ) : INTERNAL CIRCUIT DIAGRAM OF BACKLIGHT

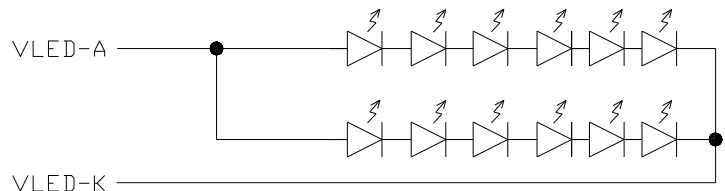

NOTE ( 3 ) : MAXIMUM ALLOWED CURRENT IN LEDS VS. TEMPERATURE ARE AUTOMATICALLY ADJUSTED BY SYSTEM CONTROLLER.

NOTE ( 4 ) : CONDITIONS; TA=25 °C, CONTINUOUS LIGHTING

NOTE ( 5 ) : DEFINITIONS OF FAILURE  
LCD LUMINANCE BECOMES HALF OF THE INITIAL VALUE.

5. TIMING CHARACTERISTICS

REFER TO STM32F746 DATA SHEET

6. MCU CHARACTERISTICS

PARAMETER	MEMORY SIZE	REMARK
SD RAM	8 MB	
FLASH	16 MB	

NOTE : THE FLASH MEMORY SIZE CAN BE UP TO 64MB

7. OPTICAL CHARACTERISTICS (NOTE 1)

7.1 OPTICAL CHARACTERISTICS

Ta = 25°C

ITEM	SYMBOL	CONDITION	MIN.	TYP.	MAX.	UNIT	REMARK	
VIEWING ANGLE	$\theta_{y+}$	CR ≥ 10	50	55	—	deg.	NOTE ( 2 ) NOTE ( 3 )	
	$\theta_{y-}$							$\theta_x=0^\circ$
	$\theta_{x+}$		$\theta_y=0^\circ$	70	75			—
	$\theta_{x-}$			70	75			—
CONTRAST RATIO	CR	$\theta_x=0^\circ, \theta_y=0^\circ$	300	400	—	—	NOTE ( 3 )	
RESPONSE TIME	t r ( rise )	$\theta_x=0^\circ, \theta_y=0^\circ$	—	5	—	ms	NOTE ( 4 )	
	t f ( fall )		—	15	—			
THE BRIGHTNESS OF MODULE	B	$\theta_x=0^\circ, \theta_y=0^\circ$	350	380	—	cd/m <sup>2</sup>	NOTE ( 5 )	
COLOR OF CIE COORDINATE	WHITE	Wx	$\theta_x=0^\circ, \theta_y=0^\circ$ NTSC : 50%	0.27	0.32	0.37	—	NOTE ( 6 )
		Wy		0.295	0.345	0.395		
	RED	Rx		0.56	0.59	0.62	—	
		Ry		0.305	0.34	0.375		
	GREEN	Gx		0.3	0.33	0.36	—	
		Gy		0.555	0.59	0.625		
	BLUE	Bx		0.115	0.145	0.175	—	
		By		0.075	0.11	0.145		
THE BRIGHTNESS OF UNIFORMITY	—	$\theta_x=0^\circ, \theta_y=0^\circ$	70	75	—	%	NOTE ( 5 )	

NOTE ( 1 ) : TEST EQUIPMENT SETUP :

AFTER STABILIZING AND LEAVING THE PANEL ALONE AT A GIVEN TEMPERATURE FOR 30 MINUTES. MEASUREMENT SHOULD BE EXECUTED IN A STABLE, WINDLESS, AND DARK ROOM. OPTICAL SPECIFICATIONS ARE MEASURED BY TOPCON BM-7 (FAST) WITH A VIEWING ANGLE OF 1° AT A DISTANCE OF 50cm AND NORMAL DIRECTION.

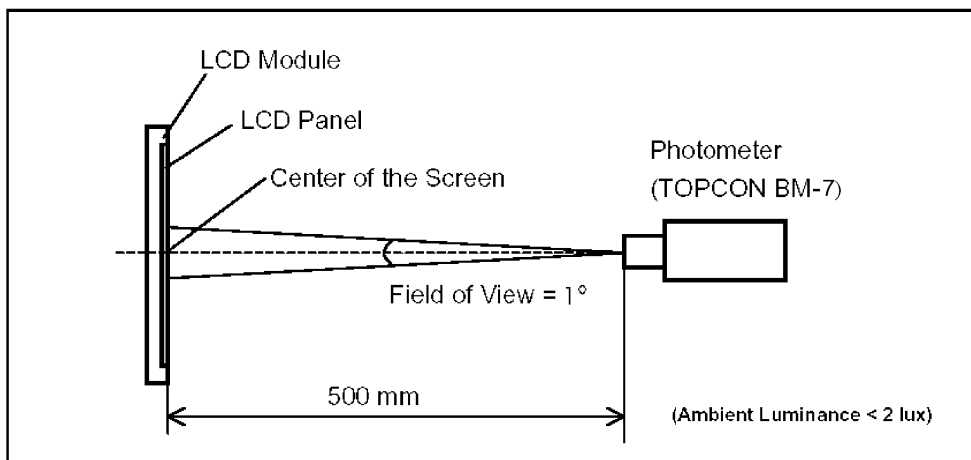



NOTE ( 2 ) : DEFINITION OF VIEWING ANGLE :

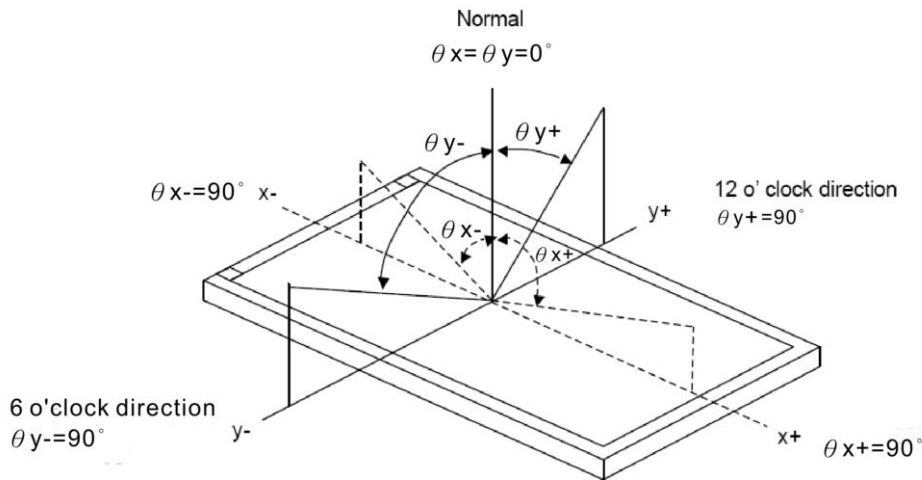

NOTE ( 3 ) : DEFINITION OF CONTRAST RATIO :

$$\text{CONTRAST RATIO(CR)} = \frac{\text{BRIGHTNESS MEASURED WHEN LCD IS AT "WHITE STATE"}}{\text{BRIGHTNESS MEASURED WHEN LCD IS AT "BLACK STATE"}}$$

NOTE ( 4 ) : DEFINITION OF RESPONSE TIME : TR AND TF

THE FIGURE BELOW IS THE OUTPUT SIGNAL OF THE PHOTO DETECTOR.

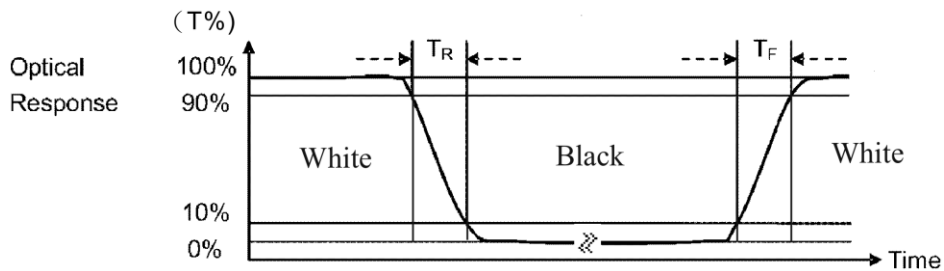

NOTE ( 5 ) : MEASURED AT THE CENTER AREA OF THE PANEL WHEN ALL THE INPUT TERMINALS OF

LCD PANEL ARE ELECTRICALLY OPENED.

NOTE ( 6 ) : THE 100% TRANSMISSION IS DEFINED AS THE TRANSMISSION OF LCD PANEL WHEN ALL

THE INPUT TERMINALS OF MODULE ARE ELECTRICALLY OPENED.

### 7.2 THE BRIGHTNESS TEST METHOD

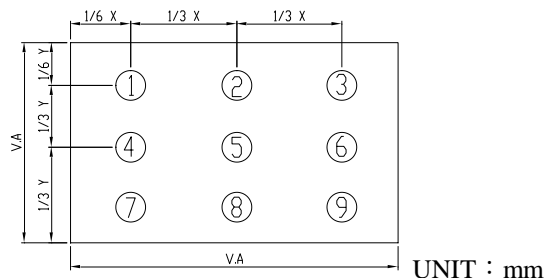

### 7.3 THE BRIGHTNESS UNIFORMITY CALCULATE METHOD

$$\text{UNIFORMITY: } \left[ 1 - \frac{\text{MAXIMUM BRIGHTNESS} - \text{MINIMUM BRIGHTNESS}}{\text{AVERAGE BRIGHTNESS}} \right] \times 100\%$$



8. OUTLINE DIMENSIONS

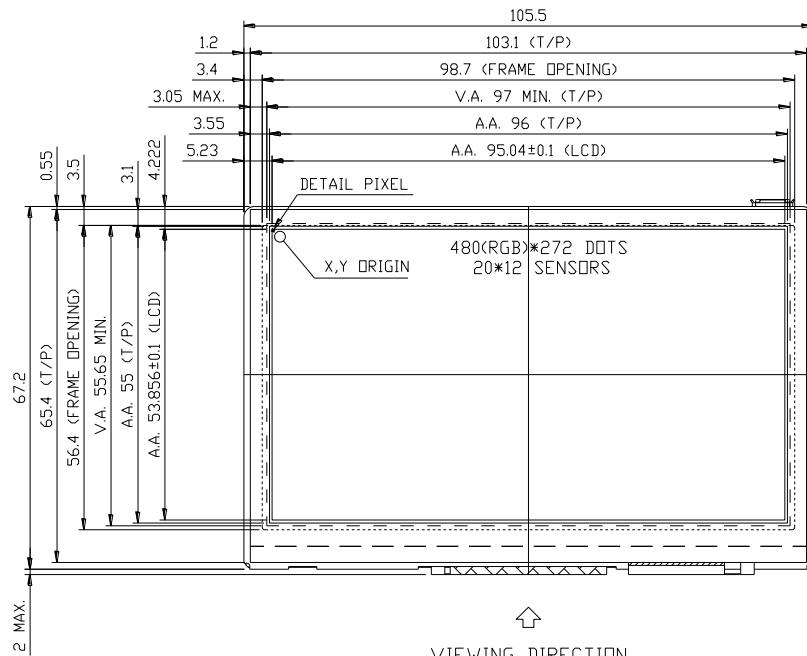

VIEWING DIRECTION  
Best Contrast but with Gray Level Inversion

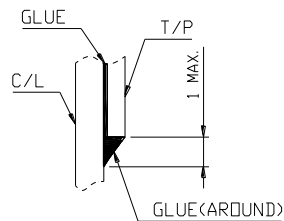

GLUE EXTENSION LIMITATION

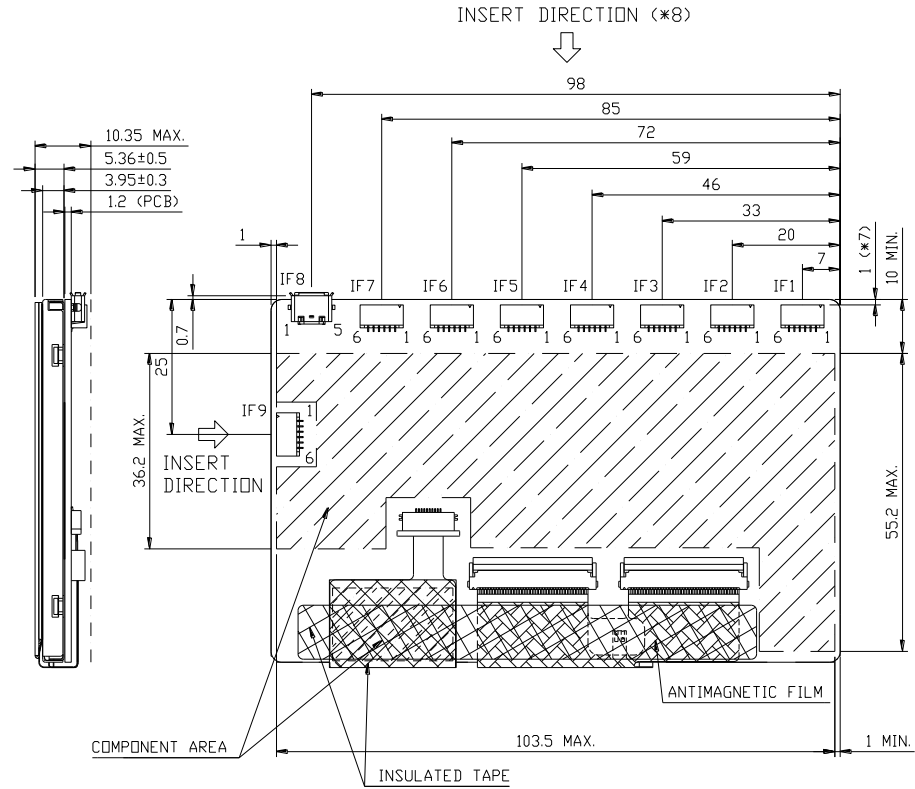

UNIT : mm  
SCALE : NTS  
NOT SPECIFIED TOLERANCE IS ± 0.5  
NOTE :

1. IF4~IF10, IF12 : JST-SM06B-SRSS-TB(LF)(SN)
2. IF11 : MOLEX-47590-0001

9. DETAIL DRAWING OF DOT MATRIX

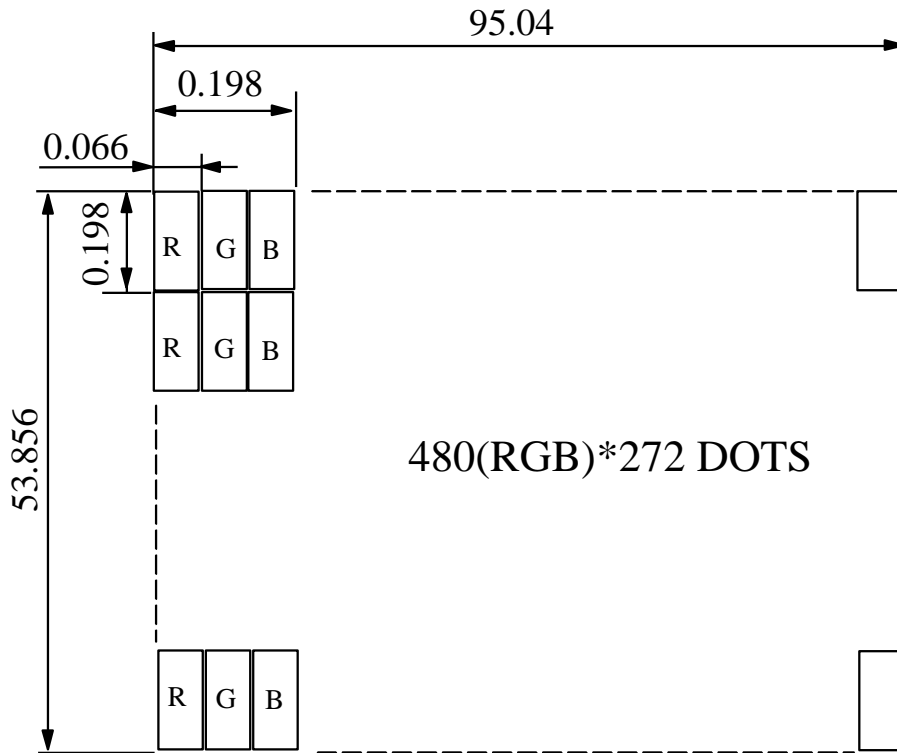

UNIT : mm  
 SCALE : NTS  
 NOT SPECIFIED TOLERANCE IS  $\pm 0.1$   
 DOTS MATRIX TOLERANCE IS  $\pm 0.01$

10. BLOCK DIAGRAM

10.1 BLOCK DIAGRAM

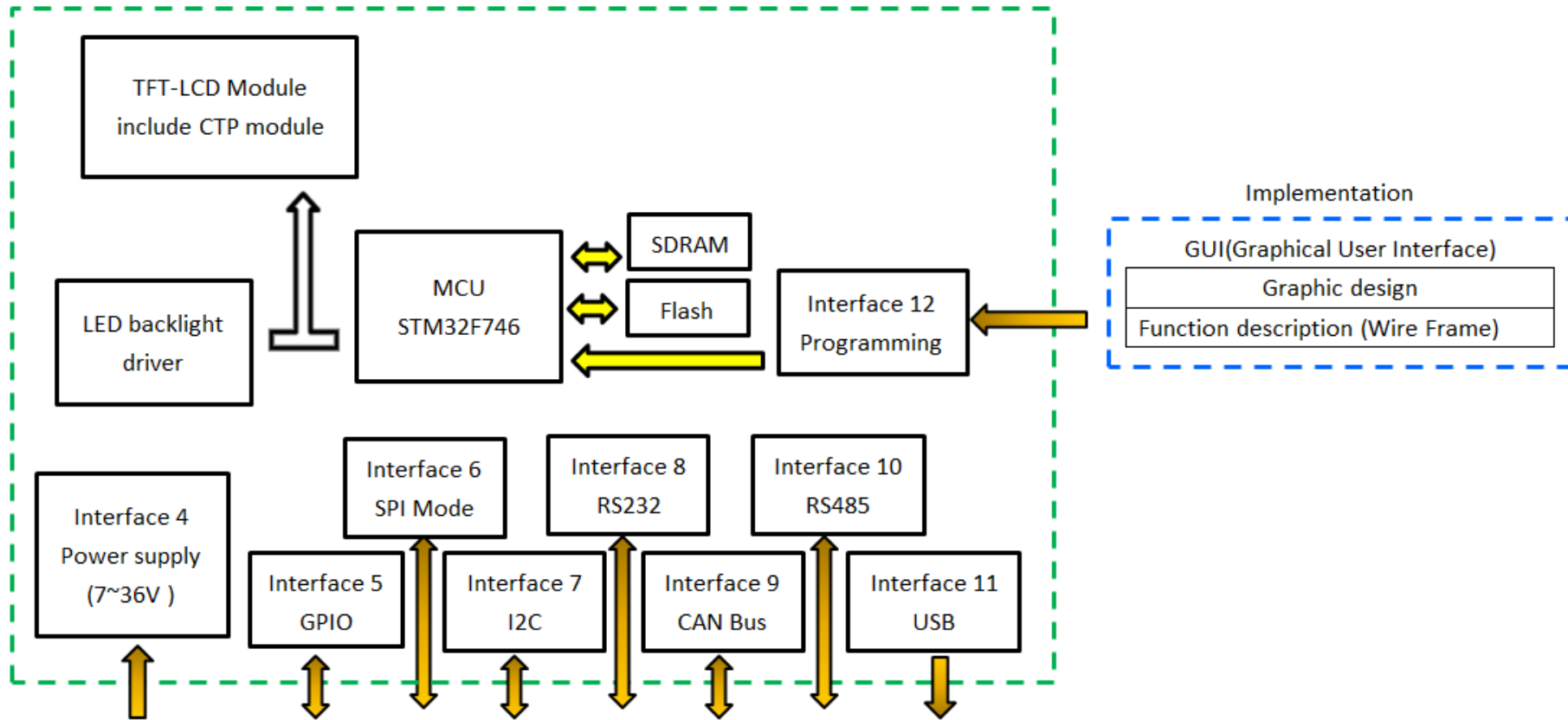

## 10.2 IMPLEMENTATION TURN-KEY SOLUTION

BUSINESS MODEL	IMPLEMENTATION	GRAPHIC DESIGN
MODEL 1	EDT	EDT
MODEL 2	EDT	CUSTOMER / THIRD PARTY
MODEL 3	CUSTOMER / THIRD PARTY	CUSTOMER / THIRD PARTY

NOTE : THE MODEL 3 WILL REQUIRE THE SOFTWARE IMPLEMENTATION BY CUSTOMER OR A THIRD PARTY. CUSTOMER OR THIRD PARTY WILL NEED TO PROVIDE A BIN OR HEX FILE TO EDT DURING INITIAL DESIGN/DEVELOPMENT STAGE OF PROJECT, AND COULD REFERENCE TouchGFX FOR THIS DEVELOPMENT.

## 11. INTERFACE SIGNALS

### 11.1 IF4 POWER SUPPLY INTERFACE

PIN NO.	SYMBOL	FUNCTION
1	VP_IN	POWER SUPPLY (7~36V)
2	VP_IN	POWER SUPPLY (7~36V)
3	VP_EN	POWER SUPPLY ENABLE (INTERNAL PULL HIGH)
4	NC	POWER SUPPLY (5V) (JUMPER OPTION)
5	VSS	GROUND
6	VSS	GROUND

### 11.2 IF5 GPIO INTERFACE

PIN NO.	SYMBOL	FUNCTION
1	GPIO1	GPIO FUNCTION PER CUSTOMER REQUEST
2	GPIO2	GPIO FUNCTION PER CUSTOMER REQUEST
3	GPIO3	GPIO FUNCTION PER CUSTOMER REQUEST
4	GPIO4	GPIO FUNCTION PER CUSTOMER REQUEST
5	GPIO5	GPIO FUNCTION PER CUSTOMER REQUEST
6	GPIO6	GPIO FUNCTION PER CUSTOMER REQUEST

### 11.3 IF6 SPI INTERFACE

PIN NO.	SYMBOL	FUNCTION
1	VDD(3V3)	3.3V OUTPUT
2	SPI_NSS	CHIP SELECT SIGNAL
3	SPI_SCK	SERIAL CLOCK
4	SPI_MISO	SERIAL DATA OUTPUT
5	SPI_MOSI	SERIAL DATA INPUT
6	VSS	GROUND

### 11.4 IF7 I2C INTERFACE

PIN NO.	SYMBOL	FUNCTION
1	VDD(3V3)	3.3V OUTPUT
2	I2C_SCL	CLOCK INPUT
3	I2C_SDA	DATA INPUT AND OUTPUT
4	I2C_INT	INTERRUPT SIGNAL
5	I2C_RST	RESET SIGNAL
6	VSS	GROUND

11.5 IF8 RS232 INTERFACE

PIN NO.	SYMBOL	FUNCTION
1	VSS	GROUND
2	RTS	REQUEST TO SEND
3	TX1	TRANSMIT DATA
4	RX1	RECEIVE DATA
5	CTS	CLEAR TO SEND
6	VSS	GROUND

11.6 IF9 CAN BUS INTERFACE

PIN NO.	SYMBOL	FUNCTION
1	VSS	GROUND
2	VSS	GROUND
3	CANL	LOW LEVEL CAN BUS SIGNAL
4	CANH	HIGH LEVEL CAN BUS SIGNAL
5	VSS	GROUND
6	VSS	GROUND

11.7 IF10 RS485 INTERFACE

PIN NO.	SYMBOL	FUNCTION
1	VSS	GROUND
2	VSS	GROUND
3	RS485A	RS485-A
4	RS485B	RS485-B
5	VSS	GROUND
6	VSS	GROUND

11.8 IF11 USB INTERFACE

PIN NO.	SYMBOL	FUNCTION
1	VBUS	VBUS
2	DM	USB D -
3	DP	USB D+
4	ID	ID
5	VSS	GROUND

11.9 IF12 PROGRAMMING INTERFACE

PIN NO.	SYMBOL	FUNCTION
1	5V	POWER SUPPLY (5V OUTPUT)
2	SWO	SWO
3	SWDIO	DATA
4	SWCLK	CLOCK
5	NRST	RESET
6	VSS	GROUND



12. POWER SUPPLY

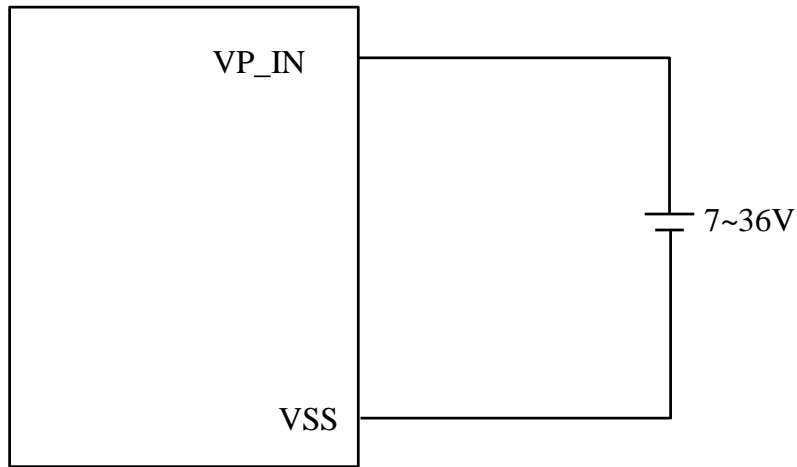

13. CAPACITIVE TOUCH PANEL SPECIFICATION

13.1 HARDNESS

ITEM	DESCRIPTION
SURFACE HARDNESS	7H (min)

13.2 DURABILITY

USING STEEL BALL AND FALLING ON TOUCH PANEL SURFACE, FROM THE HEIGHT MUST PASS BELOW CONDITIONS :

ITEM	CONDITION	INSPECTION METHOD	DESCRIPTION
STEEL BALL DROP TEST	WEIGHT : 67g HEIGHT OF FALL : 30 cm	VISUAL INSPECTION	SIGN OF FRACTURE OR DAMAGE IS NOT ACCEPTABLE 3 TIMES/ 1 POINTS, 25°C(CENTER TEST)

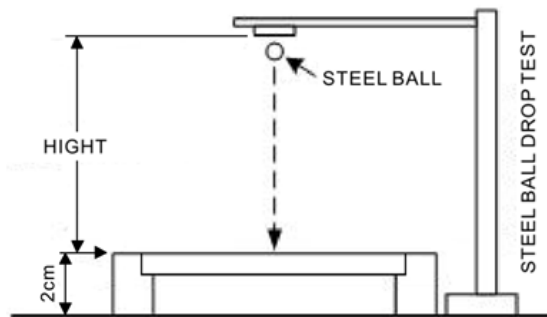

14. INSPECTION CRITERION

14.1 APPLICATION

THIS INSPECTION STANDARD IS TO BE APPLIED TO THE LCD MODULE DELIVERED FROM EMERGING DISPLAY TECHNOLOGIES CORP.( E.D.T ) TO CUSTOMERS

14.2 INSPECTION CONDITIONS

14.2.1 (1)OBSERVATION DISTANCE : 35±5cm

(2)VIEW ANGLE : ±45°

PERPENDICULAR TO MODULE SURFACE

VIEWING ANGLE SHOULD BE SMALLER THAN 45°

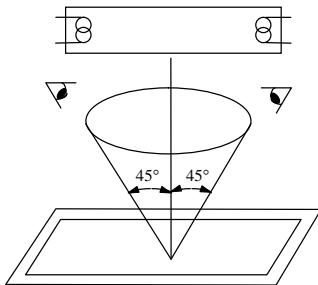

LINE OF SIGHT FOR INSPECTION SHALL BE WITHIN THE HALF SECTION OF THE VIEWING CONE GENERATED BY LINE SEGMENT 45° WITH RESPECTS TO THE VERTICAL AXIS FROM CENTER VERTEX OF LCD, THE CONE AXIS MUST BE PERPENDICULAR NORMAL TO LCD SURFACE AND PASSES THROUGH THE FLUORESCENT LAMP.

14.2.2 ENVIRONMENT CONDITIONS :

AMBIENT TEMPERATURE		25±5°C
AMBIENT HUMIDITY		65 ± 20%RH
AMBIENT ILLUMINATION	COSMETIC INSPECTION	600~800 lux
	FUNCTIONAL INSPECTION	300~500 lux
INSPECTION TIME		15 secs

14.2.3 INSPECTION LOT

QUANTITY PER DELIVERY LOT FOR EACH MODEL

14.2.4 A SAMPLING INSPECTION SHALL BE MADE ACCORDING TO THE FOLLOWING PROVISIONS TO JUDGE THE ACCEPTABILITY

(a)APPLICABLE STANDARD :

MIL-STD-105E LEVEL II

NORMAL INSPECTION, SINGLE SAMPLING

(b)AQL : MAJOR DEFECT : AQL 0.65

MINOR DEFECT : AQL 1.0

14.3 DEFECTS CLASSIFICATION

TYPE OF DEFECT	INSPECTION ITEM	DEFECT FEATURE	AQL
MAJOR DEFECT	1.DISPLAY ON	<ul style="list-style-type: none"> <li>• DEFECT TO MISS SPECIFIED DISPLAY FUNCTION, FOR ALL AND SPECIFIED DOTS</li> <li>EX: DISCONNECTION, SHORT CIRCUIT ETC</li> </ul>	0.65
	2.CTP FUNCTION	<ul style="list-style-type: none"> <li>• NO FUNCTION</li> <li>• BROKEN LINE</li> <li>• FALSE TOUCH</li> </ul>	
	3.BACKLIGHT	<ul style="list-style-type: none"> <li>• NO LIGHT</li> <li>• FLICKERING AND OTHER ABNORMAL ILLUMINATION</li> </ul>	
	4.DIMENSIONS	<ul style="list-style-type: none"> <li>• SUBJECT TO INDIVIDUAL ACCEPTANCE SPECIFICATIONS</li> </ul>	
MINOR DEFECT	1.DISPLAY ZONE (VIEWING AREA)	<ul style="list-style-type: none"> <li>• BLACK/WHITE SPOT / CIRCULAR TYPE</li> <li>• BUBBLES ON POLARIZER</li> <li>• NEWTON RING</li> <li>• BLACK/WHITE LINE / LINEAR TYPE</li> <li>• SCRATCH</li> <li>• CONTAMINATION</li> <li>• UNEVEN COLOR SPREAD</li> </ul>	1.0
	2.BEZEL ZONE	<ul style="list-style-type: none"> <li>• STAINS</li> <li>• SCRATCHES</li> <li>• FOREIGN MATTER</li> </ul>	
	3.SOLDERING	<ul style="list-style-type: none"> <li>• INSUFFICIENT SOLDER</li> <li>• SOLDERED IN INCORRECT POSITION</li> <li>• CONVEX SOLDERING SPOT</li> <li>• SOLDER BALLS</li> <li>• SOLDER SCRAPS</li> </ul>	
	4.DISPLAY ON (ALL ON)	<ul style="list-style-type: none"> <li>• LIGHT LINE</li> </ul>	

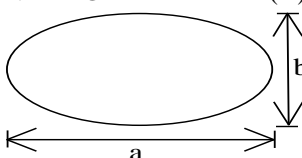
NO.	ITEM	CRITERIA																				
1	DISPLAY ON INSPECTION	1. INCORRECT PATTERN 2. MISSING SEGMENT 3. DIM SEGMENT 4. OPERATING VOLTAGE BEYOND SPEC																				
2	OVERALL DIMENSIONS	1. OVERALL DIMENSION BEYOND SPEC																				
3	DOT DEFECT	<p>1. INSPECTION PATTERN: FULL WHITE, FULL BLACK, RED, GREEN AND BLUE SCREENS.</p> <p>2.</p> <table border="1"> <thead> <tr> <th>ITEMS</th> <th>PERMISSIBLE NO.</th> </tr> </thead> <tbody> <tr> <td>BRIGHT DOT</td> <td><math>N \leq 2</math></td> </tr> <tr> <td>DARK DOT</td> <td><math>N \leq 3</math></td> </tr> <tr> <td>TOTAL BRIGHT AND DARK DOTS</td> <td><math>N \leq 4</math></td> </tr> </tbody> </table> <p>NOTE :</p> <p>(1)THE DEFINITION OF DOT : THE SIZE OF A DEFECTIVE DOT OVER 1/2 OF WHOLE DOT IS REGARDED AS ONE DEFECTIVE DOT.</p> <p>(2)BRIGHT DOT : DOTS APPEAR BRIGHT AND UNCHANGED IN SIZE IN WHICH LCD PANEL IS DISPLAYING UNDER BLACK PATTERN. THE BRIGHT DOT DEFECT MUST BE VISIBLE THROUGH 2% ND FILTER.</p> <p>(3)DARK DOT : DOTS APPEAR DARK AND UNCHANGED IN SIZE IN WHICH LCD PANEL IS DISPLAYING UNDER PURE RED, GREEN, BLUE PICTURE.</p>	ITEMS	PERMISSIBLE NO.	BRIGHT DOT	$N \leq 2$	DARK DOT	$N \leq 3$	TOTAL BRIGHT AND DARK DOTS	$N \leq 4$												
ITEMS	PERMISSIBLE NO.																					
BRIGHT DOT	$N \leq 2$																					
DARK DOT	$N \leq 3$																					
TOTAL BRIGHT AND DARK DOTS	$N \leq 4$																					
4	BUBBLES ON POLARIZER /SURFACE STAINS /DIRT/CF FAIL/SPOT	<table border="1"> <thead> <tr> <th></th> <th>AVERAGE DIAMETER (mm) : D</th> <th>PERMISSIBLE NO.</th> </tr> </thead> <tbody> <tr> <td rowspan="3">BUBBLE ON POLARIZER</td> <td><math>D \leq 0.25</math></td> <td>IGNORE</td> </tr> <tr> <td><math>0.25 &lt; D \leq 0.5</math></td> <td><math>N \leq 5</math></td> </tr> <tr> <td><math>0.5 &lt; D</math></td> <td>0</td> </tr> <tr> <td rowspan="2">SURFACE STAINS / DIRT ON POLARIZER</td> <td><math>D &lt; 0.1</math></td> <td>IGNORE</td> </tr> <tr> <td><math>0.1 &lt; D \leq 0.3</math></td> <td><math>N \leq 3</math></td> </tr> <tr> <td rowspan="2">CF FAIL / SPOT</td> <td><math>D &lt; 0.1</math></td> <td>IGNORE</td> </tr> <tr> <td><math>0.1 &lt; D \leq 0.3</math></td> <td><math>N \leq 3</math></td> </tr> </tbody> </table> <p>NOTE : (1)POLARIZER BUBBLE IS DEFINED AS THE BUBBLE APPEARS ON ACTIVE DISPLAY AREA. THE DEFECT OF POLARIZER BUBBLE SHALL BE IGNORED IF THE POLARIZER BUBBLE APPEARS ON THE OUTSIDE OF ACTIVE DISPLAY AREA.</p> <p>(2)THE EXTRANEIOUS SUBSTANCE IS DEFINED AS IT CAN BE OBSERVED WHEN THE MODULE IS POWER ON.</p> <p>(3)THE DEFINITION OF AVERAGE DIAMETER, D IS DEFINED AS FOLLOWING.</p> <p>AVERAGE DIAMETER (D)=(a+b)/2</p> 		AVERAGE DIAMETER (mm) : D	PERMISSIBLE NO.	BUBBLE ON POLARIZER	$D \leq 0.25$	IGNORE	$0.25 < D \leq 0.5$	$N \leq 5$	$0.5 < D$	0	SURFACE STAINS / DIRT ON POLARIZER	$D < 0.1$	IGNORE	$0.1 < D \leq 0.3$	$N \leq 3$	CF FAIL / SPOT	$D < 0.1$	IGNORE	$0.1 < D \leq 0.3$	$N \leq 3$
	AVERAGE DIAMETER (mm) : D	PERMISSIBLE NO.																				
BUBBLE ON POLARIZER	$D \leq 0.25$	IGNORE																				
	$0.25 < D \leq 0.5$	$N \leq 5$																				
	$0.5 < D$	0																				
SURFACE STAINS / DIRT ON POLARIZER	$D < 0.1$	IGNORE																				
	$0.1 < D \leq 0.3$	$N \leq 3$																				
CF FAIL / SPOT	$D < 0.1$	IGNORE																				
	$0.1 < D \leq 0.3$	$N \leq 3$																				

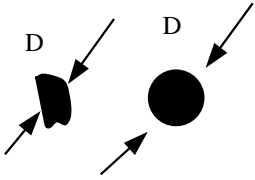
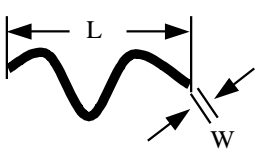
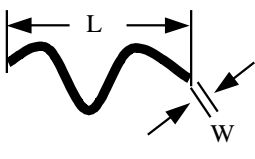
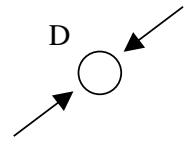
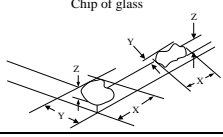
NO.	ITEM	CRITERIA											
5	BLACK/WHITE SPOT CIRCULAR TYPE	<p>THE FOLLOWING BLACK/WHITE SPOT ARE WITHIN THE VIEWING AREA. AVERAGE DIAMETER : D (mm)</p> <table border="1"> <thead> <tr> <th>SIZE D</th> <th>PERMISSIBLE NO.</th> </tr> </thead> <tbody> <tr> <td><math>D \leq 0.15</math></td> <td>IGNORE</td> </tr> <tr> <td><math>0.15 &lt; D \leq 0.3</math></td> <td>4</td> </tr> <tr> <td><math>0.3 &lt; D \leq 0.5</math></td> <td>2</td> </tr> <tr> <td><math>D &gt; 0.5</math></td> <td>0</td> </tr> </tbody> </table> <p>NOTE ( 1 ) : THE DISTANCE BETWEEN DEFECTS SHOULD BE MORE THAN 10mm APART.</p>	SIZE D	PERMISSIBLE NO.	$D \leq 0.15$	IGNORE	$0.15 < D \leq 0.3$	4	$0.3 < D \leq 0.5$	2	$D > 0.5$	0	
SIZE D	PERMISSIBLE NO.												
$D \leq 0.15$	IGNORE												
$0.15 < D \leq 0.3$	4												
$0.3 < D \leq 0.5$	2												
$D > 0.5$	0												
6	SCRATCH	<p>THE FOLLOWING SCRATCH IS WITHIN THE VIEWING AREA. WIDTH : W (mm) , LENGTH : L (mm)</p> <table border="1"> <thead> <tr> <th>SIZE W &amp; L</th> <th>PERMISSIBLE NO.</th> </tr> </thead> <tbody> <tr> <td><math>W \leq 0.05</math></td> <td>IGNORE</td> </tr> <tr> <td><math>0.05 &lt; W \leq 0.08, L \leq 8</math></td> <td>3</td> </tr> <tr> <td><math>0.08 &lt; W \leq 0.1, L \leq 5</math></td> <td>3</td> </tr> <tr> <td><math>W &gt; 0.1</math></td> <td>0</td> </tr> </tbody> </table> <p>NOTE ( 1 ) : THE DISTANCE BETWEEN DEFECTS SHOULD BE MORE THAN 10mm APART.</p>	SIZE W & L	PERMISSIBLE NO.	$W \leq 0.05$	IGNORE	$0.05 < W \leq 0.08, L \leq 8$	3	$0.08 < W \leq 0.1, L \leq 5$	3	$W > 0.1$	0	
SIZE W & L	PERMISSIBLE NO.												
$W \leq 0.05$	IGNORE												
$0.05 < W \leq 0.08, L \leq 8$	3												
$0.08 < W \leq 0.1, L \leq 5$	3												
$W > 0.1$	0												
7	BLACK / WHITE LINE LINEAR TYPE / FOREIGN FIBER	<p>THE FOLLOWING BLACK LINE, WHITE LINE IS WITHIN THE VIEWING AREA. WIDTH : W (mm) , LENGTH : L (mm)</p> <table border="1"> <thead> <tr> <th>SIZE W &amp; L</th> <th>PERMISSIBLE NO.</th> </tr> </thead> <tbody> <tr> <td><math>W \leq 0.05</math></td> <td>IGNORE</td> </tr> <tr> <td><math>0.05 &lt; W \leq 0.08, L \leq 8</math></td> <td>3</td> </tr> <tr> <td><math>0.08 &lt; W \leq 0.1, L \leq 5</math></td> <td>3</td> </tr> <tr> <td><math>W &gt; 0.1</math></td> <td>0</td> </tr> </tbody> </table> <p>NOTE ( 1 ) : THE DISTANCE BETWEEN DEFECTS SHOULD BE MORE THAN 10mm APART.</p>	SIZE W & L	PERMISSIBLE NO.	$W \leq 0.05$	IGNORE	$0.05 < W \leq 0.08, L \leq 8$	3	$0.08 < W \leq 0.1, L \leq 5$	3	$W > 0.1$	0	
SIZE W & L	PERMISSIBLE NO.												
$W \leq 0.05$	IGNORE												
$0.05 < W \leq 0.08, L \leq 8$	3												
$0.08 < W \leq 0.1, L \leq 5$	3												
$W > 0.1$	0												
8	BUBBLE / DENT FOR OPTICAL BONDING	<p>BUBBLES WITHIN VIEWING AREA. AVERAGE DIAMETER : D (mm)</p> <table border="1"> <thead> <tr> <th>SIZE D</th> <th>PERMISSIBLE NO.</th> </tr> </thead> <tbody> <tr> <td><math>D \leq 0.2</math></td> <td>IGNORE</td> </tr> <tr> <td><math>0.2 &lt; D \leq 0.3</math></td> <td>3</td> </tr> <tr> <td><math>0.3 &lt; D \leq 0.5</math></td> <td>1</td> </tr> <tr> <td><math>D &gt; 0.5</math></td> <td>0</td> </tr> </tbody> </table> <p>NOTE ( 1 ) : THE DISTANCE BETWEEN DEFECTS SHOULD BE MORE THAN 10mm APART.</p>	SIZE D	PERMISSIBLE NO.	$D \leq 0.2$	IGNORE	$0.2 < D \leq 0.3$	3	$0.3 < D \leq 0.5$	1	$D > 0.5$	0	
SIZE D	PERMISSIBLE NO.												
$D \leq 0.2$	IGNORE												
$0.2 < D \leq 0.3$	3												
$0.3 < D \leq 0.5$	1												
$D > 0.5$	0												
9	CHIPPING	<table border="1"> <tr> <td>CORNER</td> <td><math>X \leq 3\text{mm} \cdot Y \leq 3\text{mm} \cdot Z \leq t</math> (t : THICKNESS)</td> </tr> <tr> <td>EDGE</td> <td><math>X \leq 6\text{mm} , Y \leq 1\text{mm} , Z &lt; t</math> (t : THICKNESS)</td> </tr> </table>	CORNER	$X \leq 3\text{mm} \cdot Y \leq 3\text{mm} \cdot Z \leq t$ (t : THICKNESS)	EDGE	$X \leq 6\text{mm} , Y \leq 1\text{mm} , Z < t$ (t : THICKNESS)	<p>Chip of glass</p> 						
CORNER	$X \leq 3\text{mm} \cdot Y \leq 3\text{mm} \cdot Z \leq t$ (t : THICKNESS)												
EDGE	$X \leq 6\text{mm} , Y \leq 1\text{mm} , Z < t$ (t : THICKNESS)												
10	CRACKED GLASS	NOT ACCEPTABLE											
11	LINE DEFECT ON DISPLAY	OBVIOUS VERTICAL OR HORIZONTAL LINE DEFECT IS NOT ALLOWED.											
12	MURA ON DISPLAY	IT'S ACCEPTABLE, IF MURA IS SLIGHT VISIBLE THROUGH 5% ND FILTER.											
13	UNEVEN COLOR SPREAD, COLORATION	TO BE DETERMINED BASED UPON THE LIMITED SAMPLE.											
14	BEZEL APPEARANCE	<p>1. BEZEL MAY NOT HAVE RUST, BE DEFORMED OR HAVE FINGER PRINTS STAINS OF OTHER CONTAMINATION.</p> <p>2. BEZEL MUST COMPLY WITH JOB SPECIFICATIONS.</p>											

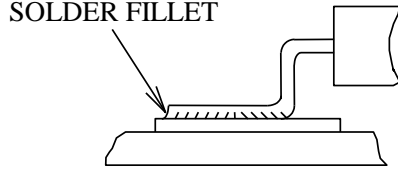
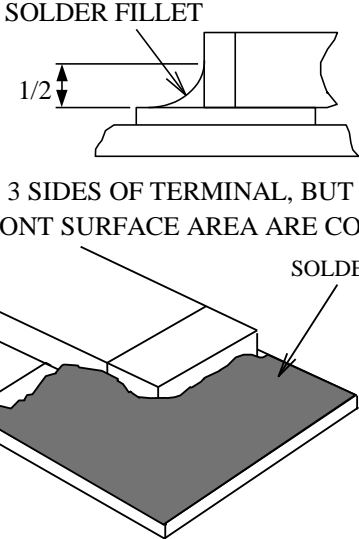
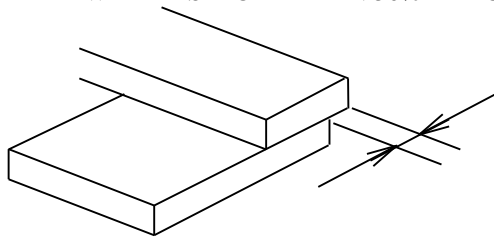
NO.	ITEM	CRITERIA
15	PCB	<p>1. THERE MAY NOT BE MORE THAN 2mm OF SEALANT OUTSIDE THE SEAL AREA ON THE PCB, AND THERE SHOULD BE NO MORE THAN THREE PLACES.</p> <p>2. NO OXIDATION OR CONTAMINATION ON PCB TERMINALS.</p> <p>3. PARTS ON PCB MUST BE THE SAME AS ON THE PRODUCTION CHARACTERISTIC CHART. THERE SHOULD BE NO WRONG PARTS, MISSING PARTS OR EXCESS PARTS.</p> <p>4. THE JUMPER ON THE PCB SHOULD CONFORM TO THE PRODUCT CHARACTERISTIC CHART.</p> <p>5. IF SOLDER GETS ON BEZEL TAB PADS, LED PAD, ZEBRA PAD OR SCREW HOLD PAD; MAKE SURE IT IS SMOOTHED DOWN.</p>
16	SOLDERING	<p>1. NO SOLDERING FOUND ON THE SPECIFIED PLACE</p> <p>2. INSUFFICIENT SOLDER</p> <p>(a)LSI, IC A POOR WETTING OF SOLDER IS BETWEEN LOWER BEND OR "HEEL" OF LEAD AND PAD</p>  <p>(b)CHIP COMPONENT · SOLDER IS LESS THAN 50% OF SIDES AND FRONT FACE WETTING</p>  <p>· SOLDER WETS 3 SIDES OF TERMINAL, BUT LESS THAN 25% OF SIDES AND FRONT SURFACE AREA ARE COVERED</p> <p>3. PARTS ALIGNMENT</p> <p>(a)LSI, IC LEAD WIDTH IS MORE THAN 50% BEYOND PAD OUTLINE</p> 

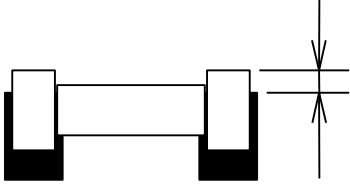
NO.	ITEM	CRITERIA
16	SOLDERING	<p>(b)CHIP COMPONENT COMPONENT IS OFF CENTER, AND MORE THAN 50% OF THE LEADS IS OFF THE PAD OUTLINE</p>  <p>4. NO UNMELTED SOLDER PASTE MAY BE PRESENT ON THE PCB. 5. NO COLD SOLDER JOINTS, MISSING SOLDER CONNECTIONS, OXIDATION OR ICICLE. 6. NO RESIDUE OR SOLDER BALLS ON PCB. 7. NO SHORT CIRCUITS IN COMPONENTS ON PCB.</p>
17	BACKLIGHT	<p>1. NO LIGHT 2. FLICKERING AND OTHER ABNORMAL ILLUMINATION 3. SPOTS OR SCRATCHES THAT APPEAR WHEN LIT MUST BE JUDGED USING LCD SPOT, LINES AND CONTAMINATION STANDARDS. 4. BACKLIGHT DOESN'T LIGHT OR COLOR IS WRONG.</p>
18	GENERAL APPEARANCE	<p>1. NO OXIDATION, CONTAMINATION, CURVES OR, BENDS ON INTERFACE PIN (OLB) OF TCP. 2. NO CRACKS ON INTERFACE PIN (OLB) OF TCP. 3. NO CONTAMINATION, SOLDER RESIDUE OR SOLDER BALLS ON PRODUCT. 4. THE IC ON THE TCP MAY NOT BE DAMAGED, CIRCUITS. 5. THE UPPERMOST EDGE OF THE PROTECTIVE STRIP ON THE INTERFACE PIN MUST BE PRESENT OR LOOK AS IF IT CAUSE THE INTERFACE PIN TO SEVER. 6. THE RESIDUAL ROSIN OR TIN OIL OF SOLDERING (COMPONENT OR CHIP COMPONENT) IS NOT BURNED INTO BROWN OR BLACK COLOR. 7. SEALANT ON TOP OF THE ITO CIRCUIT HAS NOT HARDENED. 8. PIN TYPE MUST MATCH TYPE IN SPECIFICATION SHEET. 9. LCD PIN LOOSE OR MISSING PINS. 10. PRODUCT PACKAGING MUST BE THE SAME AS SPECIFIED ON PACKAGING SPECIFICATION SHEET. 11. PRODUCT DIMENSION AND STRUCTURE MUST CONFORM TO PRODUCT SPECIFICATION SHEET. 12. THE APPEARANCE OF HEAT SEAL SHOULD NOT ADMIT ANY DIRT AND BREAK.</p>

NOTE ( 1 ) : FOR ANY SPOTS OR LINES, WHICH ARE NOT OBSERVED UNDER APPROPRIATE PANEL OPERATING CONDITION ARE DEEMED ACCEPTABLE.

NOTE ( 2 ) : THE FOREIGN MATERIALS THAT CAN BE BLOWN OUT BY AIR AND REMOVED BY WET CLEANING ARE NOT REGARDED AS DEFECTS.

15. RELIABILITY TEST

15.1 STANDARD SPECIFICATIONS FOR RELIABILITY OF LCD MODULE

NO.	ITEM	DESCRIPTION
1	HIGH TEMPERATURE OPERATION	THE SAMPLE SHOULD BE ALLOWED TO STAND AT +70°C FOR 240 HRS
2	LOW TEMPERATURE OPERATION	THE SAMPLE SHOULD BE ALLOWED TO STAND AT -20°C FOR 240 HRS
3	HIGH TEMPERATURE STORAGE	THE SAMPLE SHOULD BE ALLOWED TO STAND AT +80°C FOR 240 HRS
4	LOW TEMP STORAGE	THE SAMPLE SHOULD BE ALLOWED TO STAND AT -30°C FOR 240 HRS
5	HIGH TEMPERATURE /HUMIDITY TEST STORAGE	THE SAMPLE SHOULD BE ALLOWED TO STAND AT 60°C, 90% RH 240 HRS
6	THERMAL SHOCK (NOT OPERATED)	<p>THE SAMPLE SHOULD BE ALLOWED TO STAND THE FOLLOWING 10 CYCLES OF OPERATION:</p>
7	ESD (ELECTROSTATIC DISCHARGE) (NOT OPERATED)	AIR DISCHARGE ± 12KV CONTACT DISCHARGE ± 8KV ACCORDING TO IEC-61000-4-2

NOTE ( 1 ) : THE TEST SAMPLES HAVE RECOVERY TIME FOR 2 HOURS AT ROOM TEMPERATURE BEFORE THE FUNCTION CHECK. IN THE STANDARD CONDITIONS, THERE IS NO DISPLAY FUNCTION FAILURE ISSUE OCCURRED.

15.2 TESTING CONDITIONS AND INSPECTION CRITERIA

FOR THE FINAL TEST THE TESTING SAMPLE MUST BE STORED AT ROOM TEMPERATURE FOR 24 HOURS, AFTER THE TESTS LISTED IN TABLE 14.1, STANDARD SPECIFICATIONS FOR RELIABILITY HAVE BEEN EXECUTED IN ORDER TO ENSURE STABILITY.

NO.	ITEM	TEST MODEL	INSPECTION CRITERIA
1	CURRENT CONSUMPTION	REFER TO SPECIFICATION	THE CURRENT CONSUMPTION SHOULD CONFORM TO THE PRODUCT SPECIFICATION.
2	CONTRAST	REFER TO SPECIFICATION	AFTER THE TESTS HAVE BEEN EXECUTED, THE CONTRAST MUST BE LARGER THAN HALF OF ITS INITIAL VALUE PRIOR TO THE TESTS.
3	APPEARANCE	VISUAL INSPECTION	DEFECT FREE



## 16. PRECAUTION

### 16.1 OPERATION

- 16.1.1 DO NOT CONNECT OR DISCONNECT MODULES TO OR FROM THE MAIN SYSTEM WHILE POWER IS BEING SUPPLIED .
- 16.1.2 USE THE MODULE WITHIN SPECIFIED TEMPERATURE ; LOWER TEMPERATURE CAUSES THE RETARDATION OF BLINKING SPEED OF THE DISPLAY ; HIGHER TEMPERATURE MAKES OVERALL DISPLAY DISCOLOR. WHEN THE TEMPERATURE RETURNS TO NORMALITY, THE DISPLAY WILL OPERATE NORMALLY .
- 16.1.3 ADJUST THE LC DRIVING VOLTAGE TO OBTAIN THE OPTIMUM CONTRAST.
- 16.1.4 POWER ON SEQUENCE INPUT SIGNALS SHOULD NOT BE SUPPLIED TO LCD MODULE BEFORE POWER SUPPLY VOLTAGE IS APPLIED AND REACHES THE SPECIFIED VALUE .  
IF ABOVE SEQUENCE IS NOT FOLLOWED , CMOS LSIS OF LCD MODULES MAY BE DAMAGED DUE TO LATCH - UP PROBLEM .
- 16.1.5 NOT ALLOWED TO INFLICT ANY EXTERNAL STRESS AND TO CAUSE ANY MECHANICAL INTERFERENCE ON THE BENDING AREA OF FPC DURING THE TAIL BENDING BACKWARDS!  
DO NOT STRESS FPC AND IC ON THE MODULE!

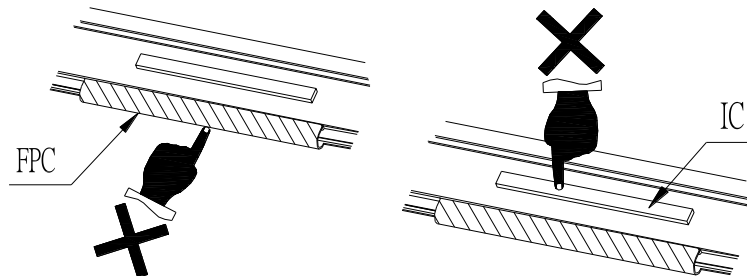

MODEL NO .	VERSION	PAGE
ETEM043005XDH6	1	21

## 16.2 HANDLING

- 16.2.1 USE A GROUNDED SOLDERING IRON WHEN SOLDERING CONNECTOR I/O TERMINALS . FOR SOLDERING OR REPAIRING, TAKE PRECAUTION AGAINST THE TEMPERATURE OF THE SOLDERING IRON AND THE SOLDERING TIME TO PREVENT PEELING OFF THE THROUGH-HOLE-PAD .
- 16.2.2 DO NOT DISASSEMBLE . EDT SHALL NOT BE HELD RESPONSIBLE IF THE MODULE IS DISASSEMBLED AND UPON THE REASSEMBLY THE MODULE FAILED .
- 16.2.3 DO NOT CHARGE STATIC ELECTRICITY , AS THE CIRCUIT OF THIS MODULE CONTAINS CMOS LSIS. A WORKMAN'S BODY SHOULD ALWAYS BE STATIC-PROTECTED BY USE OF AN ESD STRAP. WORKING CLOTHES FOR SUCH PERSONNEL SHOULD BE OF STATIC-PROTECTED MATERIAL .
- 16.2.4 ALWAYS GROUND THE ELECTRICALLY-POWERED DRIVER BEFORE USING IT TO INSTALL THE LCD MODULE. WHILE CLEANING THE WORK STATION BY VACUUM CLEANER, DO NOT BRING THE SUCKING MOUTH NEAR THE MODULE ; STATIC ELECTRICITY OF THE ELECTRICALLY-POWERED DRIVER OR THE VACUUM CLEANER MAY DESTROY THE MODULE .
- 16.2.5 DON'T GIVE EXTERNAL SHOCK.
- 16.2.6 DON'T APPLY EXCESSIVE FORCE ON THE SURFACE.
- 16.2.7 LIQUID CRISTAL IN LCD IS HAZARDOUS SUBSTANCE. MUST NOT LICK AND SWALLOW.  
WHEN THE LIQUID IS ATTACH TO YOUR, SKIN, CLOTH ETC.  
WASH IT OUT THOROUGHLY AND IMMEDIATELY.
- 16.2.8 DON'T OPERATE IT ABOVE THE ABSOLUTE MAXIMUM RATING.
- 16.2.9 STORAGE IN A CLEAN ENVIRONMENT, FREE FROM DUST, ACTIVE GAS, AND SOLVENT.
- 16.2.10 STORE WITHOUT ANY PHYSICAL LOAD.
- 16.2.11 REWIRING: NO MORE THAN 3 TIMES.